

Please read the instructions before assembly!

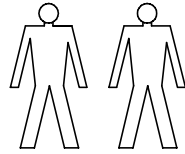

Tools needed for assembly

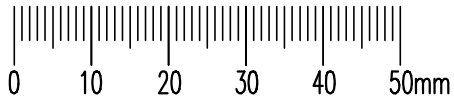

20 min

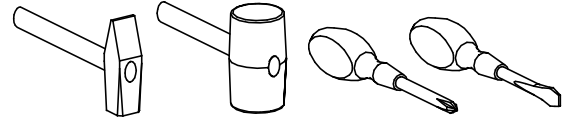

KYOTO

Important information:

1) remove the protective foil if the table is in high gloss

2) Add more elements for the coffee table to be higher

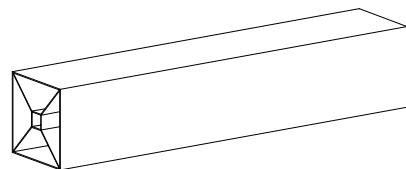
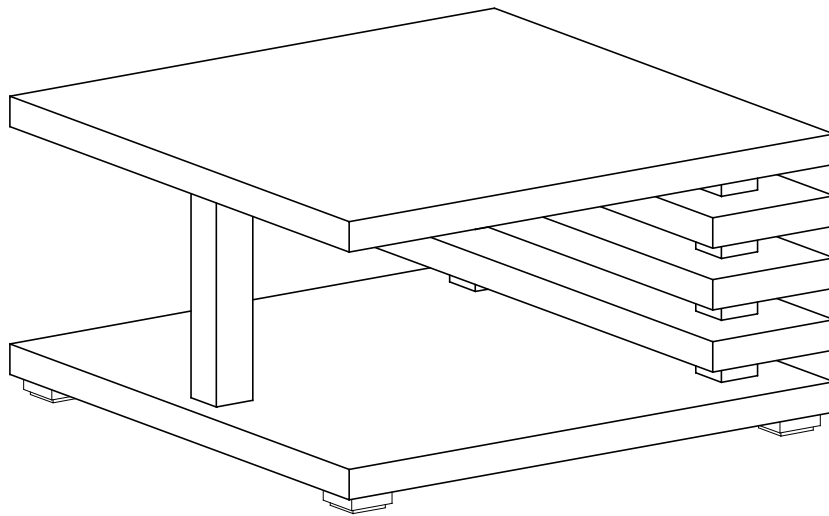
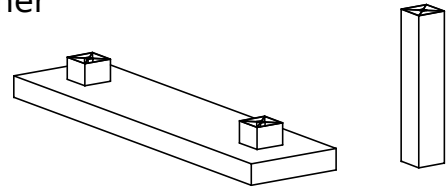

S - 1 St.

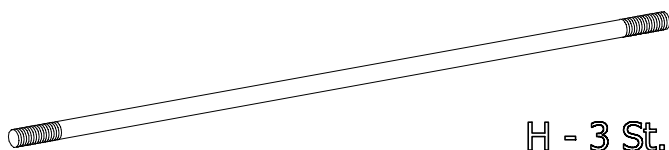

H - 3 St.

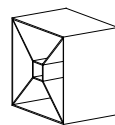

G - 8 St.

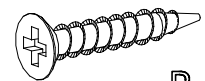

R - 16 St.
4 x 30 mm

B - 3 St.

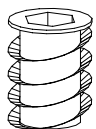

F - 3 St.

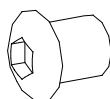

P - 4 St.

